



# LLAMBRICH

Since 1957

**Industrial Drill Chucks**

**& Live Centers**

From our headquarters in the province of Barcelona, Spain, **Llambrih Precisi3n, S.L.** has been designing and manufacturing drill chucks and machine tool accessories since 1957. The recognized quality and bottom line of our products has allowed us to export our products for more than 55 years to countries worldwide.

We are fully committed to the research and development for the continuous improvement for all of our products. Because of this we can offer an exclusive full range of drill chucks to meet our customer's needs and demands.

Llambrih's name stands for quality and innovative design worldwide, and are proud to hold both ISO 9001 & 13485 certifications.



## Manufacturing program

Our wide range of products includes drill chuck and accessories for industrial and medical use. This catalog is showing our industrial drill chucks series only.

Please ask us for our Surgical Drill Chucks catalog in case you are also interested in these other series.

Llambrich drill chucks are designed for high precision drilling. All of our products are made on and inspected by state of the art equipment.

## Quality statement

Llambrich is proud to hold both ISO 9001 and ISO 13485 certifications.

Llambrich has been the pioneer and inventor of the precision keyless chuck that guarantees the lowest run-out of concentricity since 1983. All high performance drill chucks come with a certificate of inspection that guarantees a maximum run-out of 0,03mm, 0,04mm or 0,05mm (.0012", .0016" or .0019").

Inspections for concentricity are performed adhering to the most demanding standards in the metalworking industry.

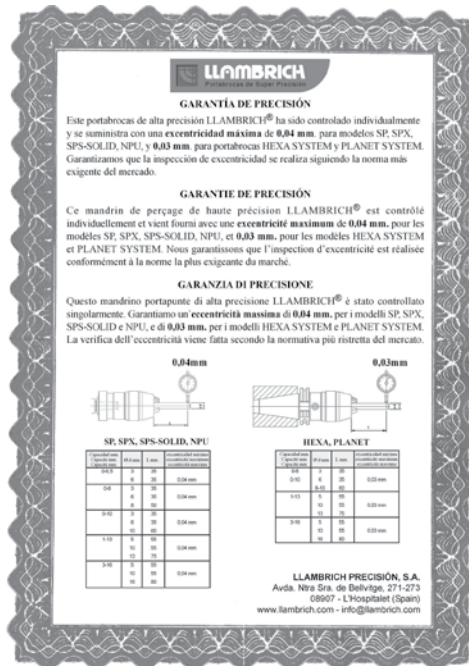

Certificate of Inspection

# index

## HYBRID

Combined precision keyless and keyed drill chuck

- SPH

Page 6 & 7



## SP, SPX, SPS-SOLID

Precision self-tightening Drill Chucks

- SP
- SPX
- SPS-SOLID

Page 8 & 9



## NPU

Precision self-tightening Drill Chucks with integrated Shank

- DIN-69871, MAS-BT, DIN-2080
- CAT-ANSI, VDI, STRAIGHT SHANK
- HSK, NPU-B (drill chuck head)

Page 10 & 11



## HEXA

Precision Drill Chucks with integrated Shank and Hexagonal Key lock

- DIN-69871, MAS-BT, DIN-2080, HSK
- MORSE, STRAIGHT SHANK, VDI, CAT-ANSI
- R-8, HEXA-B (drill chuck head)

Page 12 & 13



## HEXA BLACK

Standard Drill Chucks with integrated Shank and Hexagonal Key lock

- DIN-69871, MAS-BT,
- DIN-2080, CAT-ANSI

Page 14 & 15



## MICRO DRILL

### Micro Drill Chucks and Adapters

- Micro Drill Chucks
- Sensitive Drill Adapters
- KITS

Page 16 & 17



## CKS, CKX, CPL, CPX & CPM

### Self-tightening Drill Chucks - medium duty - & Keyless Drill Chuck for portable drilling machines

- CKS Self-tightening
- CKX Self-tightening + with security lock
- CPL
- CPX
- CPM

Page 18 & 19



## CY, CBB, CL & SDS-Converter

### Key-type Drill Chucks - SDS Drill Chuck

- CY
- CBB
- CL
- SDS-Converter

Page 20 & 21



## Arbors, Drill Sleeves and Ejectors

- Arbors
- Drill Sleeves
- Extension Sleeves
- Ejectors

Page 22 & 23

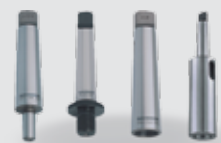

## Live Centers

- Precision Live Centers
- Live Centers with small casing diameter

Page 24 & 25



## Replacement Parts & Adapters

Page 26



## HYBRID

**This unique chuck, designed and patented by Llambrich combines the features and benefits of both a keyed and keyless drill chuck.**

- Another solution offered first by the world's leader of drill chucks from Barcelona, Spain, Llambrich.
- The Hybrid combines the high accuracy of a keyless chuck with the gripping force of a keyed chuck.
- Self-tightening feature automatically increases gripping force in proportion to the increase of torque to prevent tool slippage.



### Features & Benefits

The Hybrid is furnished with a key to allow additional gripping torque.

The tool better resists loosening on high speed machines that have instant spindle stop. .04 mm (.0016") repeatability on taper mounted chucks. Llambrich, the leader in precision.

Special designs, sizes, and mounts for all types of applications are available upon request.



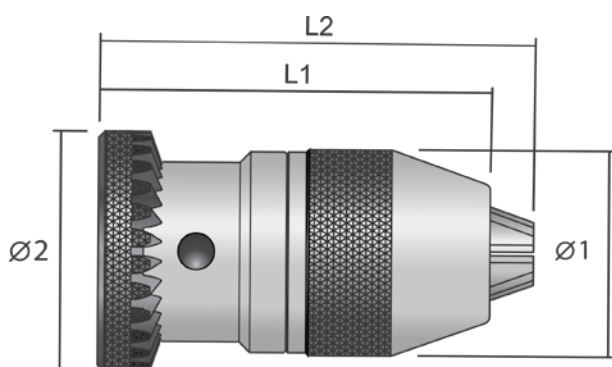

MODEL	CAPACITY		MOUNT	KEY	SIZES mm.				WEIGHT
no.	mm.	inches	K	model	Ø1	Ø2	L1	L2	gr.
SPH-06 B12	0,3 - 8	1/64" - 5/16"	B12	K2/S17	36,5	44	72	77	460
SPH-06 J1	0,3 - 8	1/64" - 5/16"	J1	K2/S17	36,5	44	72	77	460
SPH-10 B12	0,8 - 10	1/32" - 3/8"	B12	K2/S17	40	48	79	85,5	620
SPH-10 B16	0,8 - 10	1/32" - 3/8"	B16	K2/S17	40	48	79	85,5	620
SPH-10 J2	0,8 - 10	1/32" - 3/8"	J2	K2/S17	40	48	79	85,5	620
SPH-10 J33	0,8 - 10	1/32" - 3/8"	J33	K2/S17	40	48	79	85,5	620
SPH-13 B16	0,8 - 13	1/32" - 1/2"	B16	K3/S10	47	51	93	103	1060
SPH-13 J2	0,8 - 13	1/32" - 1/2"	J2	K3/S10	47	51	93	103	1060
SPH-13 J33	0,8 - 13	1/32" - 1/2"	J33	K3/S10	47	51	93	103	1060
SPH-13 J6	0,8 - 13	1/32" - 1/2"	J6	K3/S10	47	51	93	103	1060
SPH-16 B16	3 - 16	1/8" - 5/8"	B16	K3/S10	51,5	53	95	105,5	1210
SPH-16 B18	3 - 16	1/8" - 5/8"	B18	K3/S10	51,5	53	95	105,5	1210
SPH-16 J16	3 - 16	1/8" - 5/8"	J6	K3/S10	51,5	53	95	105,5	1210
SPH-20 B18	5 - 20	13/64" - 3/4"	B18	K4/S13	64	74	121	130	2300
SPH-20 J3	5 - 20	13/64" - 3/4"	J3	K4/S13	64	74	121	130	2300

## Applications

Specifically designed for high precision drilling.

The Hybrid series is well suited for use on drill presses with high accuracy, jigbore machines, horizontal or vertical milling machines, and production drilling machines where the application requires higher feed rates.



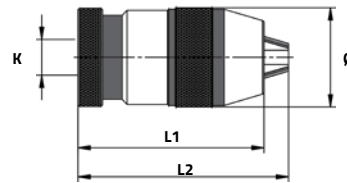

## SP

### Super Precision Keyless Drill Chuck

- Maximum total integrated run-out of 0,04 mm.
- Self-tightening feature automatically increases gripping force in proportion to increased torque to prevent tool shank slippage. For right-hand rotation applications only.
- Permits use on high accuracy drill presses, jig borers, milling machines and production drilling equipment.
- All components exposed to wear are completely hardened to maintain accuracy and extend chuck life.
- Also available with through hole, for EDM machines, on demand.

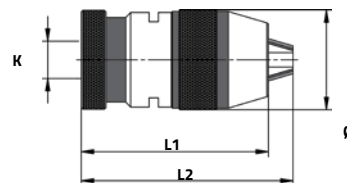

## SPX

### Super Precision Keyless Drill Chuck, with supplementary gripping torque

- SPX drill chucks offer the same features as SP, with the advantage of being furnished with milled wrench flats and spanner wrench to allow application of supplementary gripping torque. Light tightening increases gripping torque up to 3 times higher than hand tightening.
- For use on CNC machines in drilling, boring, counter-boring and milling operations requiring heavy feed.
- Resistance to tool loosening on high-speed machines with instant spindle stop.



MODEL no.	CAPACITY		MOUNT K	SIZES mm.			WEIGHT gr.
	mm.	inches		Ø	L1	L2	
SP-1.5 B-6	0,2 - 1,5	0,008" - 1/16"	B-6	19,4	35	37,3	80
SP-1.5 J-0	0,2 - 1,5	0,008" - 1/16"	J-0	19,4	35	37,3	80
SP-03 B-6	0,3 - 3	1/64" - 1/8"	B-6	24,5	44	47,5	200
SP-03 B-10	0,3 - 3	1/64" - 1/8"	B-10	24,5	44	47,5	200
SP-03 J-0	0,3 - 3	1/64" - 1/8"	J-0	24,5	44	47,5	200
SP-03 J-1	0,3 - 3	1/64" - 1/8"	J-1	24,5	44	47,5	200
SP-03 R-5/16	0,3 - 3	1/64" - 1/8"	5/16" x 24	24,5	44	47,5	200
SP-06 B-10	0,3 - 6,5	1/64" - 1/4"	B-10	33	62	70	360
SP-06 B-12	0,3 - 6,5	1/64" - 1/4"	B-12	33	62	70	360
SP-06 J-1	0,3 - 6,5	1/64" - 1/4"	J-1	33	62	70	360
SP-08 B-12	0,3 - 8	1/64" - 5/16"	B-12	38	67	74	460
SP-08 J-1	0,3 - 8	1/64" - 5/16"	J-1	38	67	74	460
SP-08 J25	0,3 - 8	1/64" - 5/16"	J25	38	67	74	460
SP-08 R-3/8	0,3 - 8	1/64" - 5/16"	3/8" x 24	38	67	74	460
SP-10 B-12	0,5 - 10	1/32" - 3/8"	B-12	43	81	89	720
SP-10 B-16	0,5 - 10	1/32" - 3/8"	B-16	43	81	89	720
SP-10 J-2	0,5 - 10	1/32" - 3/8"	J-2	43	81	89	720
SP-10 J-33	0,5 - 10	1/32" - 3/8"	J-33	43	81	89	720
SP-10 R-3/8	0,5 - 10	1/32" - 3/8"	3/8" x 24	43	81	89	720
SP-10 R-1/2	0,5 - 10	1/32" - 3/8"	1/2" x 20	43	81	89	720
SP-13 B-16	1 - 13	1/32" - 1/2"	B-16	49	91	103	1.000
SP-13 J-2	1 - 13	1/32" - 1/2"	J-2	49	91	103	1.000
SP-13 J-33	1 - 13	1/32" - 1/2"	J-33	49	91	103	1.000
SP-13 J-6	1 - 13	1/32" - 1/2"	J-6	49	91	103	1.000
SP-13 R-1/2	1 - 13	1/32" - 1/2"	1/2" x 20	49	91	103	1.000
SP-16 B-16	3 - 16	1/8" - 5/8"	B-16	55	95	107	1.320
SP-16 B-18	3 - 16	1/8" - 5/8"	B-18	55	95	107	1.320
SP-16 J-33	3 - 16	1/8" - 5/8"	J-33	55	95	107	1.320
SP-16 J-6	3 - 16	1/8" - 5/8"	J-6	55	95	107	1.320

MODEL no.	CAPACITY		MOUNT K	SIZES mm.			WEIGHT gr.
	mm.	inches		Ø	L1	L2	
SPX-06 B-10	0,3 - 6,5	1/64" - 1/4"	B-10	33	62	70	580
SPX-06 B-12	0,3 - 6,5	1/64" - 1/4"	B-12	33	62	70	580
SPX-06 J-1	0,3 - 6,5	1/64" - 1/4"	J-1	33	62	70	580
SPX-08 B-12	0,3 - 8	1/64" - 5/16"	B-12	38	67	74	680
SPX-08 J-1	0,3 - 8	1/64" - 5/16"	J-1	38	67	74	680
SPX-08 J-25	0,3 - 8	1/64" - 5/16"	J-25	38	67	74	680
SPX-10 B-12	0,5 - 10	1/32" - 3/8"	B-12	43	81	89	940
SPX-10 B-16	0,5 - 10	1/32" - 3/8"	B-16	43	81	89	940
SPX-10 J-2	0,5 - 10	1/32" - 3/8"	J-2	43	81	89	940
SPX-10 J-33	0,5 - 10	1/32" - 3/8"	J-33	43	81	89	940
SPX-13 B-16	1 - 13	1/32" - 1/2"	B-16	49	91	103	1.220
SPX-13 J-2	1 - 13	1/32" - 1/2"	J-2	49	91	103	1.220
SPX-13 J-33	1 - 13	1/32" - 1/2"	J-33	49	91	103	1.220
SPX-13 J-6	1 - 13	1/32" - 1/2"	J-6	49	91	103	1.220
SPX-16 B-16	3 - 16	1/8" - 5/8"	B-16	55	95	107	1.540
SPX-16 B-18	3 - 16	1/8" - 5/8"	B-18	55	95	107	1.540
SPX-16 J-33	3 - 16	1/8" - 5/8"	J-33	55	95	107	1.540
SPX-16 J-6	3 - 16	1/8" - 5/8"	J-6	55	95	107	1.540



# SPS-SOLID



## Super Precision Keyless Drill Chuck with Integrated Shank (Morse taper, straight shank or R-8)

- Arbor integrated in internal socket of drill chuck; compact design.
- No possibility of taper slipping from drill chuck.
- Greater rigidity and precision.
- Maximum total integrated run-out of 0,04 mm.
- Self-tightening feature automatically increases gripping force in proportion to increased torque to prevent tool shank slippage. For right-hand rotation applications only.
- Furnished with milled wrench flats and spanner wrench to allow application of supplementary gripping torque. Light tightening increases gripping torque up to 3 times higher than hand tightening.
- Resistance to tool loosening on high-speed machines with instant spindle stop.



SPS-13 MT-3

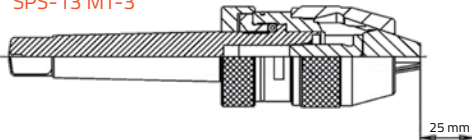

SPS-13 + arbor CM-3

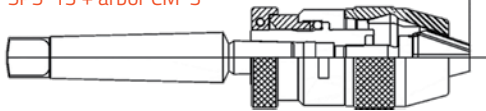

Compact Design

Greater Rigidity

High Precision

MODEL	CAPACITY		MOUNT	SIZES mm.				WEIGHT
	no.	mm. inches		K	Ø	L1	L2	
SPS-08 MT-2	0,3 - 8	1/64" - 5/16"	morse taper 2	38	65	72	-	800
SPS-10 MT-2	0,5 - 10	1/32" - 3/8"	morse taper 2	43	73	82	-	1.020
SPS-13 MT-2	1 - 13	1/32" - 1/2"	morse taper 2	48	80	92	-	1.200
SPS-13 MT-3	1 - 13	1/32" - 1/2"	morse taper 3	48	80	92	-	1.320
SPS-13 MT-4	1 - 13	1/32" - 1/2"	morse taper 4	48	80	92	-	1.580
SPS-16 MT-2	3 - 16	1/8" - 5/8"	morse taper 2	54	85	96	-	1.600
SPS-16 MT-3	3 - 16	1/8" - 5/8"	morse taper 3	54	85	96	-	1.720
SPS-16 MT-4	3 - 16	1/8" - 5/8"	morse taper 4	54	85	96	-	1.980

SPS-13 CIL-20	1 - 13	1/32" - 1/2"	Ø 20 mm.	48	80	92	60	1.320
SPS-13 CIL-25	1 - 13	1/32" - 1/2"	Ø 25 mm.	48	80	92	61	1.320
SPS-13 CIL-32	1 - 13	1/32" - 1/2"	Ø 32 mm.	48	80	92	63	1.440
SPS-16 CIL-20	3 - 16	1/8" - 5/8"	Ø 20 mm.	54	88	98	60	1.600
SPS-16 CIL-25	3 - 16	1/8" - 5/8"	Ø 25 mm.	54	88	98	61	1.680
SPS-16 CIL-32	3 - 16	1/8" - 5/8"	Ø 32 mm.	54	88	98	63	1.800

SPS-13 R-8	1 - 13	1/32" - 1/2"	R-8	48	82	90	-	1.580
SPS-16 R-8	3 - 16	1/8" - 5/8"	R-8	54	87	98	-	1.800

Morse Taper

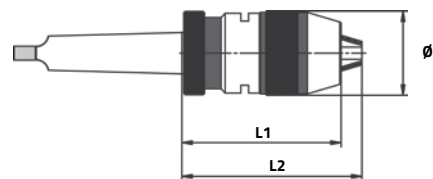

Straight Shank

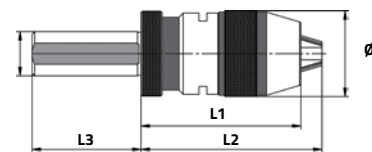

R-8

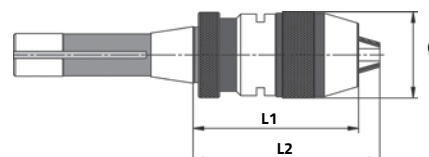

# NPU

## Super Precision Short Keyless Drill Chuck with Integrated Shank

- For use on CNC machining centres.
- Single taper connection between drill chuck and shank eliminates intermediate arbors to ensure high tool rigidity and drilling accuracy.
- Furnished with milled wrench flats and spanner wrench to allow application of supplementary gripping torque.
- Resistance to tool loosening on high-speed machines with instant spindle stop.
- Maximum total integrated run-out of 0,04 mm.



## Advantages

NPU13 - ID40

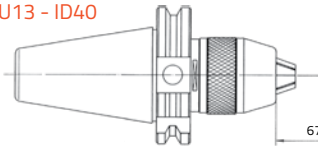

67 mm

Not integral shank

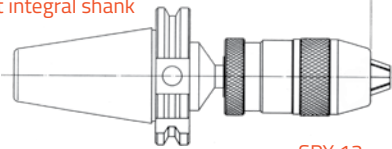

SPX 13

### 1. Compact construction

Drill chuck model SPX-13 with DIN-69871 ISO 40 shank is 67 mm longer than drill chuck NPU-13 with the same shank. Greater rigidity and precision.

### 2. Higher precision

The eccentricity is controlled by the single taper connection to the machine and no intermediate arbor is needed as with the standard drill chuck.

### 3. Retension screw

Guarantees a perfect connection between the internal arbor taper and the external arbor taper.

### 4. Maximum connection rigidity

The connection with a short Morse taper is the best due to its rigidity and precision.



### 5. Advantages of supplementary tightening by wrench

Increases gripping torque up to three times higher than hand tightening.

Capacities 0-3 mm and 0-6,5 mm available on request for all NPU models

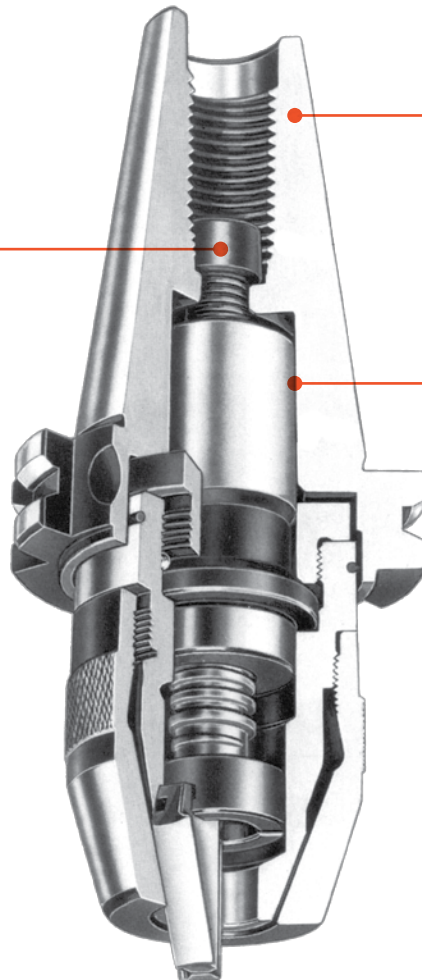

MODEL	CAPACITY		MOUNT	SIZES mm.				THREAD	WEIGHT
	no.	mm.		inches	ISO	∅	L1		
NPU-08 ID 30	0,3 - 8	1/64" - 5/16"	30	38	77	83	-	M12	1,10
NPU-08 ID 40	0,3 - 8	1/64" - 5/16"	40	38	70	76	-	M16	1,50
NPU-08 ID 40/110	0,3 - 8	1/64" - 5/16"	40/110	38	110	116	-	M16	1,95
NPU-10 ID 30	0,5 - 10	1/32" - 3/8"	30	43	86	94	-	M12	1,30
NPU-10 ID 40	0,5 - 10	1/32" - 3/8"	40	43	74	82	-	M16	1,60
NPU-10 ID 40/110	0,5 - 10	1/32" - 3/8"	40/110	43	114	122	-	M16	1,95
NPU-13 ID 40	1 - 13	1/32" - 1/2"	40	48	80	91	-	M16	1,70
NPU-13 ID 40/125	1 - 13	1/32" - 1/2"	40/125	48	130	141	-	M16	2,45
NPU-13 ID 45	1 - 13	1/32" - 1/2"	45	48	78	89	-	M20	2,50
NPU-13 ID 50	1 - 13	1/32" - 1/2"	50	48	78	89	-	M24	3,65
NPU-16 ID 40	3 - 16	1/8" - 5/8"	40	55	97	108	-	M16	2,15
NPU-16 ID 50	3 - 16	1/8" - 5/8"	50	55	76	89	-	M24	3,75
NPU-16 ID 50/125	3 - 16	1/8" - 5/8"	50/125	55	130	140	-	M24	4,90
NPU-08 BT 30	0,3 - 8	1/64" - 5/16"	30	38	73	79	-	M12	1,10
NPU-08 BT 40	0,3 - 8	1/64" - 5/16"	40	38	78	84	-	M16	1,50
NPU-08 BT 40/110	0,3 - 8	1/64" - 5/16"	40/110	38	78	84	-	M16	1,90
NPU-10 BT 30	0,5 - 10	1/32" - 3/8"	30	43	89	97	-	M12	1,30
NPU-10 BT 40	0,5 - 10	1/32" - 3/8"	40	43	79	87	-	M16	1,70
NPU-10 BT 40/110	0,5 - 10	1/32" - 3/8"	40/110	43	109	117	-	M16	2,10
NPU-13 BT 40	1 - 13	1/32" - 1/2"	40	48	86	97	-	M16	1,90
NPU-13 BT 40/130	1 - 13	1/32" - 1/2"	40/130	48	136	147	-	M16	2,70
NPU-13 BT 50	1 - 13	1/32" - 1/2"	50	48	97	108	-	M24	4,60
NPU-16 BT 40	3 - 16	1/8" - 5/8"	40	55	105	116	-	M16	2,30
NPU-16 BT 50	3 - 16	1/8" - 5/8"	50	55	95	106	-	M24	4,70
NPU-16 BT 50/145	3 - 16	1/8" - 5/8"	50/145	55	145	156	-	M24	5,80
NPU-08 DIN 30	0,3 - 8	1/64" - 5/16"	30	38	70	76	-	M12	1,00
NPU-08 DIN 40	0,3 - 8	1/64" - 5/16"	40	38	63	69	-	M16	1,40
NPU-10 DIN 30	0,5 - 10	1/32" - 3/8"	30	43	77	85	-	M12	1,20
NPU-10 DIN 40	0,5 - 10	1/32" - 3/8"	40	43	72	80	-	M16	1,60
NPU-13 DIN 40	1 - 13	1/32" - 1/2"	40	48	78	89	-	M16	1,70
NPU-13 DIN 50	1 - 13	1/32" - 1/2"	50	48	71	101	-	M24	3,60
NPU-16 DIN 40	3 - 16	1/8" - 5/8"	40	55	90	101	-	M16	2,10
NPU-16 DIN 50	3 - 16	1/8" - 5/8"	50	55	72	83	-	M24	3,75
NPU-08 CA 30-A	0,3 - 8	1/64" - 5/16"	30	38	101	107	-	1/2"-13	0,85
NPU-08 CA 40-A	0,3 - 8	1/64" - 5/16"	40	38	82	88	-	5/8"-11	1,30
NPU-13 CA 40-A	1 - 13	1/32" - 1/2"	40	48	115	126	-	5/8"-11	1,85
NPU-13 CA 45-A	1 - 13	1/32" - 1/2"	45	48	96	107	-	3/4"-10	2,25
NPU-13 CA 50-A	1 - 13	1/32" - 1/2"	50	48	96	107	-	1"-8	2,50
NPU-16 CA 40-A	3 - 16	1/8" - 5/8"	40	55	120	131	-	5/8"-11	3,65
NPU-16 CA 50-A	3 - 16	1/8" - 5/8"	50	55	94	105	-	1"-8	3,85
NPU-08 VDI 30	0,3 - 8	1/64" - 5/16"	30	38	72	79	-	-	1,85
NPU-13 VDI 30	1 - 13	1/32" - 1/2"	30	48	94	105	-	-	2,10
NPU-13 VDI 40	1 - 13	1/32" - 1/2"	40	48	85	92	-	-	2,40
NPU-16 VDI 40	3 - 16	1/8" - 5/8"	40	55	85	96	-	-	2,60
NPU-16 VDI 50	3 - 16	1/8" - 5/8"	50	55	87	98	-	-	2,65
NPU-16 VDI 60	3 - 16	1/8" - 5/8"	60	55	87	98	-	-	5,40
NPU-08 CIL 25	0,3 - 8	1/64" - 5/16"	25	38	66	73	56	-	0,85
NPU-08 CIL 30	0,3 - 8	1/64" - 5/16"	30	38	66	73	56	-	1,30
NPU-08 CIL 32	0,3 - 8	1/64" - 5/16"	32	38	66	73	56	-	1,85
NPU-13 CIL 32	1 - 13	1/32" - 1/2"	32	48	80	92	65	-	2,25
NPU-13 CIL 40	1 - 13	1/32" - 1/2"	40	48	80	92	65	-	2,50
NPU-16 CIL 40	3 - 16	1/8" - 5/8"	40	55	84	96	70	-	3,65
NPU-16 CIL 50	3 - 16	1/8" - 5/8"	50	55	84	96	70	-	3,85
NPU-13 HSK 50	1 - 13	1/32" - 1/2"	50	48	120	131	-	-	2,10
NPU-13 HSK 63	1 - 13	1/32" - 1/2"	63	48	120	131	-	-	2,30
NPU-16 HSK 63	3 - 16	1/8" - 5/8"	63	55	131	142	-	-	2,65
NPU-16 HSK 80	3 - 16	1/8" - 5/8"	80	55	134	145	-	-	3,40
NPU-16 HSK 100	3 - 16	1/8" - 5/8"	100	55	134	145	-	-	4,40
NPU-03 B	0,3 - 3	1/64" - 1/8"	B-12	24	38	41	-	-	0,12
NPU-06 B	0,3 - 6,5	1/64" - 1/4"	B-18	33	52	59	-	-	0,28
NPU-08 B	0,3 - 8	1/64" - 5/16"	B-18	38	57	64	-	-	0,38
NPU-10 B/30 <sup>(1)</sup>	0,5 - 10	1/32" - 3/8"	B-18	43	64	74	-	-	0,54
NPU-010 B/40 <sup>(2)</sup>	0,5 - 10	1/32" - 3/8"	B-18	43	64	74	-	-	0,54
NPU-13 B	1 - 13	1/32" - 1/2"	MORSE-3	48	72	84	-	-	0,76
NPU-16 B/40 <sup>(2)</sup>	3 - 16	1/8" - 5/8"	MORSE-3	54	76	88	-	-	1,06
NPU-16 B/50 <sup>(3)</sup>	3 - 16	1/8" - 5/8"	MORSE-3	54	76	88	-	-	1,06

<sup>(1)</sup> for tapers 30

<sup>(2)</sup> for tapers 40

<sup>(3)</sup> for tapers 50

DIN-69871-A

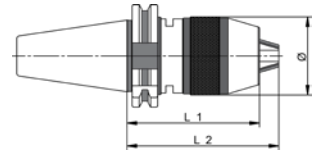

MAS 403-BT [JIS-6339A]

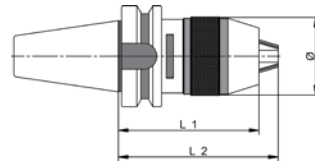

DIN-2080

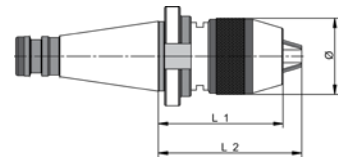

CAT-ANSI

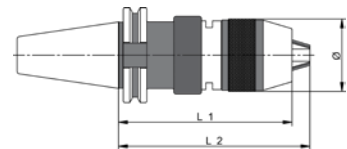

DIN-69880 VDI 3425/2

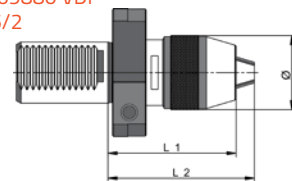

STRAIGHT SHANK

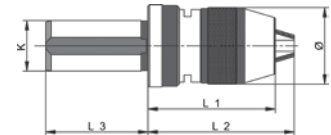

DIN-69893-A [HSK]

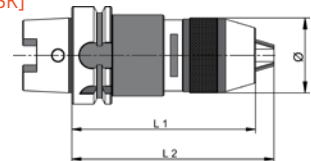

NPU-B

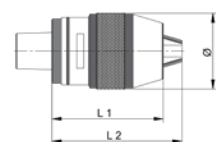

# HEXA



## Precision drill chuck with integrated shank and hexagonal key lock

- For use on high-speed CNC machines, optional through coolant for drilling, milling, reaming and tapping.
- Hexagonal key lock system.
- Permits clockwise and counterclockwise turning.
- High gripping torque, exceeding 100 Nm.
- Maximum total integrated run-out of 0.03 mm.
- Maximum coolant pressure: 50 bar.
- Maximum revolutions per minute without balancing: 8000.
- Optional balancing service up to 25.000 rpm G6,3.



## Advantages

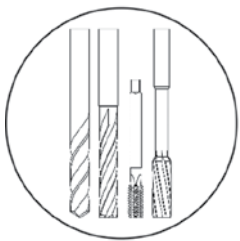
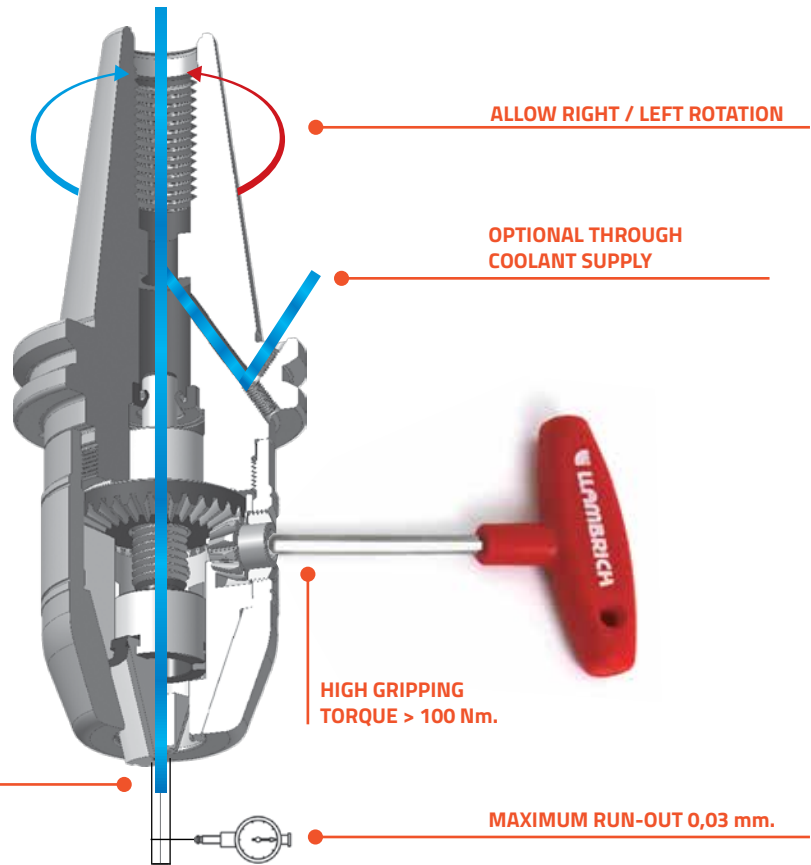

FOR DRILLING, MILLING, REAMING AND TAPPING

MODEL	CAPACITY		MOUNT	THROUGH	SIZES mm.			THREAD	WEIGHT
	no.	mm.			inches	coolant	Ø		
HX-10 ID-40	0,5 - 10	1/32" - 3/8"	40	-	43	77	85,5	M16	1,3
HX-10 ID-40/R	0,5 - 10	1/32" - 3/8"	40	B+AD	43	77	85,5	M16	1,3
HX-13 ID-40	1 - 13	1/32" - 1/2"	40	-	54	91	100	M16	1,92
HX-13 ID-40/R	1 - 13	1/32" - 1/2"	40	B+AD	54	91	100	M16	1,92
HX-13 ID-50	1 - 13	1/32" - 1/2"	50	-	54	93	102	M24	3,46
HX-13 ID-50/R	1 - 13	1/32" - 1/2"	50	B+AD	54	93	102	M124	3,46
HX-16 ID-40	3 - 16	1/8" - 5/8"	40	-	57	94	101	M16	2,10
HX-16 ID-40/R	3 - 16	1/8" - 5/8"	40	B+AD	57	94	101	M16	2,10
HX-16 ID-50	3 - 16	1/8" - 5/8"	50	-	57	96	103	M24	3,56
HX-16 ID-50/R	3 - 16	1/8" - 5/8"	50	B+AD	57	96	103	M24	3,56

DIN-69871-A  
A, B, AD

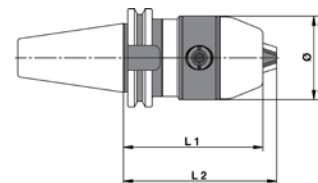

MODEL	CAPACITY		MOUNT	THROUGH	SIZES mm.			THREAD	WEIGHT
	no.	mm.			inches	coolant	Ø		
HX-10 BT-40	0,5 - 10	1/32" - 3/8"	40	-	43	86	95	M16	1,38
HX-10 BT-40/R	0,5 - 10	1/32" - 3/8"	40	B + AD	43	86	95	M16	1,38
HX-13 BT-40	1 - 13	1/32" - 1/2"	40	-	54	96	105	M16	2,04
HX-13 BT-40/R	1 - 13	1/32" - 1/2"	40	B + AD	54	96	105	M16	2,04
HX-13 BT-50	1 - 13	1/32" - 1/2"	50	-	54	107	116	M24	4,38
HX-13 BT-50/R	1 - 13	1/32" - 1/2"	50	B + AD	54	107	116	M24	4,38
HX-16 BT-40	3 - 16	1/8" - 5/8"	40	-	57	99	106	M16	2,22
HX-16 BT-40/R	3 - 16	1/8" - 5/8"	40	B + AD	57	99	106	M16	2,22
HX-16 BT-50	3 - 16	1/8" - 5/8"	50	-	57	110	117	M24	4,48
HX-16 BT-50/R	3 - 16	1/8" - 5/8"	50	B + AD	57	110	117	M24	4,48
HX-10 DIN-40	0,5 - 10	1/32" - 3/8"	40	-	43	72	81	M16	1,22
HX-13 DIN-40	1 - 13	1/32" - 1/2"	40	-	54	82	91	M16	1,84
HX-13 DIN-50	1 - 13	1/32" - 1/2"	50	-	54	85	94	M24	3,32
HX-16 DIN-40	3 - 16	1/8" - 5/8"	40	-	57	85	92	M16	2,00
HX-16 DIN-50	3 - 16	1/8" - 5/8"	50	-	57	88	95	M24	3,42
HX-13 HSK-50	1 - 13	1/32" - 1/2"	50	-	54	112	121	-	1,38
HX-13 HSK-50/R	1 - 13	1/32" - 1/2"	50	AD	54	112	121	-	1,38
HX-13 HSK-63	1 - 13	1/32" - 1/2"	63	-	54	98	107	-	1,78
HX-13 HSK-63/R	1 - 13	1/32" - 1/2"	63	AD	54	103	112	-	1,78
HX-13 HSK-100	1 - 13	1/32" - 1/2"	100	-	54	110	119	-	4,38
HX-13 HSK-100/R	1 - 13	1/32" - 1/2"	100	AD	54	98	107	-	4,38
HX-16 HSK-50	3 - 16	1/8" - 5/8"	50	-	57	115	122	-	1,88
HX-16 HSK-50/R	3 - 16	1/8" - 5/8"	50	AD	57	115	122	-	1,88
HX-16 HSK-63	3 - 16	1/8" - 5/8"	63	-	57	101	108	-	4,48
HX-16 HSK-63/R	3 - 16	1/8" - 5/8"	63	AD	57	106	113	-	4,48
HX-16 HSK-100	3 - 16	1/8" - 5/8"	100	-	57	113	120	-	4,48
HX-16 HSK-100/R	3 - 16	1/8" - 5/8"	100	AD	57	101	108	-	4,48
HX-13 MT-2	1 - 13	1/32" - 1/2"	MT-2	-	54	85	94	-	1,32
HX-13 MT-3	1 - 13	1/32" - 1/2"	MT-3	-	54	85	94	-	1,48
HX-13 MT-4	1 - 13	1/32" - 1/2"	MT-4	-	54	85	94	-	1,80
HX-16 MT-2	3 - 16	1/8" - 5/8"	MT-2	-	57	88	95	-	1,42
HX-16 MT-3	3 - 16	1/8" - 5/8"	MT-3	-	57	88	95	-	1,56
HX-16 MT-4	3 - 16	1/8" - 5/8"	MT-4	-	57	88	95	-	1,88
HX-13 CIL-20	1 - 13	1/32" - 1/2"	20	-	54	85	94	-	1,30
HX-13 CIL-25	1 - 13	1/32" - 1/2"	25	-	54	82	91	-	1,40
HX-13 CIL-32	1 - 13	1/32" - 1/2"	32	-	54	82	91	-	1,56
HX-13 CIL-40	1 - 13	1/32" - 1/2"	40	-	54	82	91	-	1,86
HX-16 CIL-20	3 - 16	1/8" - 5/8"	20	-	57	88	95	-	1,40
HX-16 CIL-25	3 - 16	1/8" - 5/8"	25	-	57	85	92	-	1,48
HX-16 CIL-32	3 - 16	1/8" - 5/8"	32	-	57	85	92	-	1,64
HX-16 CIL-40	3 - 16	1/8" - 5/8"	40	-	57	85	92	-	1,94
HX-13 VDI-30	1 - 13	1/32" - 1/2"	30	-	54	90	99	-	1,74
HX-13 VDI-40	1 - 13	1/32" - 1/2"	40	-	54	92	101	-	2,30
HX-13 VDI-50	1 - 13	1/32" - 1/2"	50	-	54	96	105	-	3,32
HX-16 VDI-30	3 - 16	1/8" - 5/8"	30	-	57	93	100	-	1,82
HX-16 VDI-40	3 - 16	1/8" - 5/8"	40	-	57	95	102	-	2,38
HX-16 VDI-50	3 - 16	1/8" - 5/8"	50	-	57	99	106	-	3,40
HX-10 CA40	0,5 - 10	1/32" - 3/8"	40	-	43	100	108,5	5/8" - 11	1,50
HX-10 CA40/R	0,5 - 10	1/32" - 3/8"	40	B+AD	43	100	108,5	5/8" - 11	1,50
HX-13 CA40	1 - 13	1/32" - 1/2"	40	-	54	107	116	5/8" - 11	2,18
HX-13 CA40/R	1 - 13	1/32" - 1/2"	40	B+AD	54	107	116	5/8" - 11	2,18
HX-13 CA50	1 - 13	1/32" - 1/2"	50	-	54	88	97	1" - 8	3,86
HX-13 CA50/R	1 - 13	1/32" - 1/2"	50	B+AD	54	94	103	1" - 8	3,86
HX-16 CA40	3 - 16	1/8" - 5/8"	40	-	57	110	117	5/8" - 11	2,30
HX-16 CA40/R	3 - 16	1/8" - 5/8"	40	B+AD	57	110	117	5/8" - 11	2,30
HX-16 CA50	3 - 16	1/8" - 5/8"	50	-	57	91	98	1" - 8	3,96
HX-16 CA50/R	3 - 16	1/8" - 5/8"	50	B+AD	57	97	104	1" - 8	3,96
HX-13 R-8	1 - 13	1/32" - 1/2"	R-8	-	54	85	94	-	1,58
HX-16 R-8	3 - 16	1/8" - 5/8"	R-8	-	57	88	95	-	1,66
HX-10 B	0,5 - 10	1/32" - 3/8"	Morse 4	-	43	60	69	-	0,72
HX-10 B/R	0,5 - 10	1/32" - 3/8"	Morse 4	B+AD	43	60	69	-	0,72
HX-13 B	1 - 13	1/32" - 1/2"	Morse 4	-	54	73	85	-	1,12
HX-13 B/R	1 - 13	1/32" - 1/2"	Morse 4	B+AD	54	73	85	-	1,12
HX-16 B	3 - 16	1/8" - 5/8"	Morse 4	-	57	76	87	-	1,22
HX-16 B/R	3 - 16	1/8" - 5/8"	Morse 4	B+AD	57	76	87	-	1,22

MAS 403-BT [JIS-6339A]  
A, B, AD

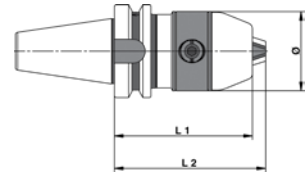

DIN-2080

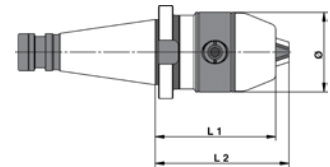

DIN-69893-A [HSK]

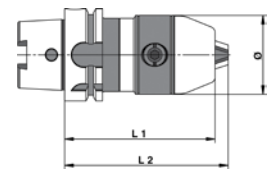

MORSE

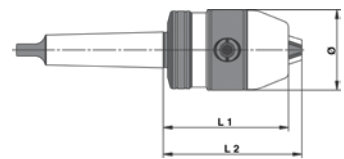

STRAIGHT SHANK

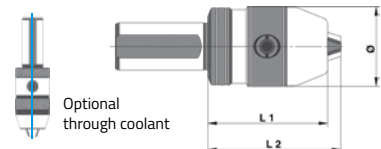

DIN-69880 VDI  
A, AD

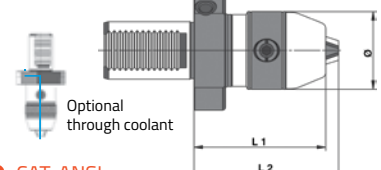

CAT-ANSI  
A, AD

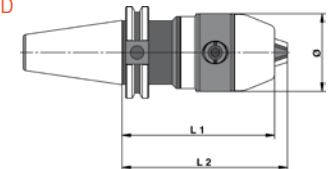

R-8

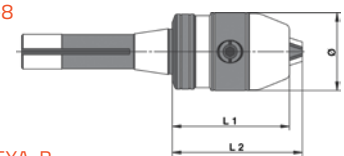

HEXA-B

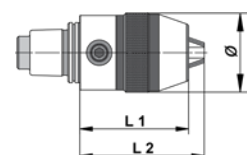

# HEXA BLACK

Standard drill chuck with integrated shank and hexagonal key lock.  
Great quality at a fair price

- For use on CNC machines, for drilling, milling, reaming and tapping.
- Hexagonal key lock system.
- Permits clockwise and counterclockwise rotating.
- High gripping torque, exceeding 100 Nm. = 75 ft/lbs
- Maximum total indicator run-out of 0.05 mm. = .0019"
- Maximum revolutions per minute without balancing: 8000.



ALLOWS FOR RIGHT OR LEFT HAND ROTATION

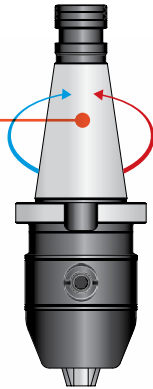

MODEL	CAPACITY		MOUNT	THROUGH	SIZES mm.			THREAD	WEIGHT
no.	mm.	inches	ISO	coolant	∅	L1	L2	p.stud	kg.
HB-13 ID-40	1 - 13	1/32" - 1/2"	40	-	54	91	100	M16	1,92
HB-16 ID-40	3 - 16	1/8" - 5/8"	40	-	57	94	101	M16	2,10

HB-13 BT-40	1 - 13	1/32" - 1/2"	40	-	54	96	105	M16	2,04
HB-16 BT-40	3 - 16	1/8" - 5/8"	40	-	57	99	106	M16	2,22

HB-13 DIN-40	1 - 13	1/32" - 1/2"	40	-	54	82	91	M16	1,84
HB-16 DIN-40	3 - 16	1/8" - 5/8"	40	-	57	85	92	M16	2,00

HB-13 CA40	1 - 13	1/32" - 1/2"	40	-	54	107	116	M16	2,18
HB-16 CA40	3 - 16	1/8" - 5/8"	40	-	57	110	117	M16	2,30

DIN-69871

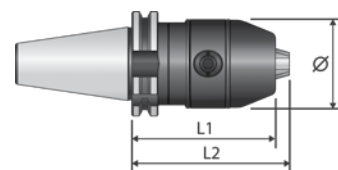

MAS-BT

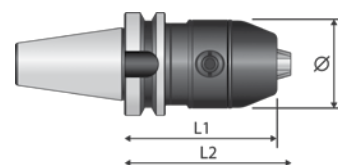

DIN-2080

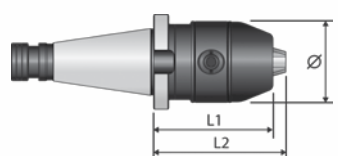

CAT-ANSI

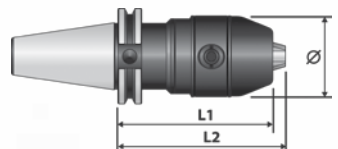

# Micro DRILL

## Chucks & Adapters

**Ideal for micro hole drilling**

**Very accurate and sensitive for precise drilling**

- Ideal for micro hole drilling.
- From 0.2 mm (0.008") to 4 mm (0.156") capacities, with the combination of a Micro Drill Chuck (3 types available) and a Sensitive Drill Feed (2 types available)

## Features & Benefits

- Precision  $\pm 0.04$  mm (0.0016")
- Very accurate and sensitive for precise drilling.
- Longer tool life and less occurrence of catastrophic tool failure.
- To be used in mills, lathes, drill presses, jigbore and Swiss machines.
- Eliminates the need of secondary operations to drill small holes. Spindle speeds up to 50.000 RPM (SP-1.5)
- All micro drill chucks available upon request with thru hole for EDM machines.
- Micro Drill Chucks and Adapters can be supplied separately, or as part of a KIT (up to 6 combinations are available)

## Simple to use

- Feed with gentle finger pressure.
- Free turning knurled ring.
- Spring return upon release.
- 20 mm (3/4") total travel.
- Standard  $\varnothing$  13 mm (1/2") straight shank or #1 morse taper to go directly into the spindle of your machine or it can be held with a rotary toolholder or drill chuck.

*... for a wide range of applications*

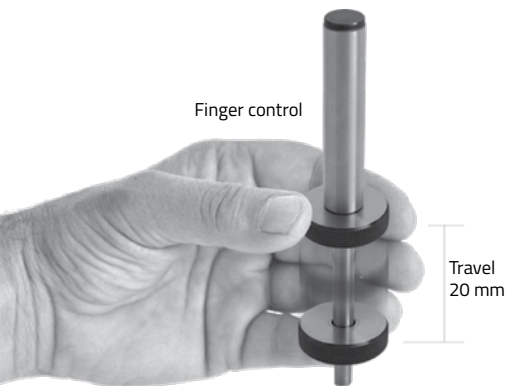

Aerospace



Electronics



Job Shops



**Micro Drill Chucks**

MODEL		CAPACITY		MOUNT	KEY	SIZES mm.			WEIGHT
no.	mm.	inches	K	model	∅	L1	L2	gr.	
SP-1.5 J0/B6	0,2 - 1,5	.008"-1/16"	J0/B6	-	19,3	35,3	37,5	50	
SP-03 J0/B6	0,3 - 3	1/64"-1/8"	J0/B6	-	24,5	44,0	47,5	200	
CY-04 J0/B6	0,5 - 4	1/64"-54/32"	J0/B6	K0	22,0	29,0	36,0	50	

**Sensitive Drill Adapters**

MODEL No.	SHANK	MOUNT	WEIGHT gr.
EL-MT1/J0/B6	morse taper 1	J0/B6	95
ECIL-13/J0/B6	∅ 13mm	J0/B6	100

**Drill Chucks and Adapter KITS**

KIT No.	DRILL CHUCK	ADAPTER	WEIGHT gr.
KIT #1	SP-1,5 J0/B6	ECIL-13/JT0/B6	150
KIT #2	SP-1,5 J0/B6	EL-MT1/JT0/B6	145
KIT #3	SP-03 J0/B6	ECIL-13/JT0/B6	300
KIT #4	SP-03 J0/B6	EL-MT1/JT0/B6	295
KIT #5	CY-04 J0/B6	ECIL-13/JT0/B6	150
KIT #6	CY-04 J0/B6	EL-MT1/JT0/B6	145

KITS include FREE wedge for removing chuck from adapter



Attractive & safe packaging for KITS

SP-1.5 J0/B6

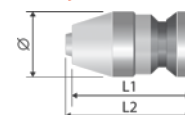

SP-03 J0/B6

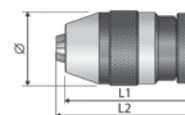

CY-04 J0/B6

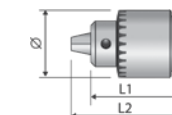

EL-MT1/J0/B6



ECIL-13/J0/B6



KIT #1



KIT #2



KIT #3



KIT #4



KIT #5



KIT #6



Medical Industry



Metalworking



Hobby Industry



Watch and Jewelry



## CKS

### Keyless Drill Chuck for portable drilling machines or stationary machines

- Drill chucks for industrial use (medium duty), available with screw fittings for professional portable drilling machines and with taper fittings for stationary drilling machines.
- Automatic fitting for efficient, fast change of tools.
- Self-tightening mechanism automatically increases the grip in proportion to the increase in torque during the drilling and avoids the tool slipping in clockwise rotation.
- Fits tools of up to 20 mm in diameter.
- Machine fitting via DIN-238 or JACOBS tapers and UNF thread fittings.

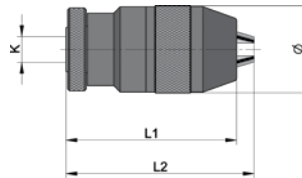

MODEL no.	CAPACITY		MOUNT K	SIZES mm.			WEIGHT gr.
	mm.	inches		Ø	L1	L2	
CKS-04 B-10	0,5 - 4	1/64" - 5/32"	B - 10	26	50	55	170
CKS-04 J-1	0,5 - 4	1/64" - 5/32"	J - 1	26	50	55	170
CKS-06 B-12	0,5 - 6,5	1/64" - 1/4"	B - 12	34	63	70	310
CKS-06 J-1	0,5 - 6,5	1/64" - 1/4"	J - 1	34	63	70	310
CKS-06 R-3/8	0,5 - 6,5	1/64" - 1/4"	3/8" x 24h.	34	63	70	310
CKS-08 B-10	0,8 - 8	1/32" - 5/16"	B - 10	37	72	78	450
CKS-08 B-12	0,8 - 8	1/32" - 5/16"	B - 12	37	72	78	430
CKS-08 R-3/8	0,8 - 8	1/32" - 5/16"	3/8" x 24h.	37	72	78	450
CKS-08 R-1/2	0,8 - 8	1/32" - 5/16"	1/2" x 20h.	37	72	78	450
CKS-08 J-1	0,8 - 8	1/32" - 5/16"	J - 1	37	72	78	430
CKS-08 J-25	0,8 - 8	1/32" - 5/16"	J - 2	37	72	78	430
CKS-10 B-12	0,8 - 10	1/32" - 3/8"	B - 12	40	79	86	560
CKS-10 B-16	0,8 - 10	1/32" - 3/8"	B - 16	40	79	86	560
CKS-10 R-3/8	0,8 - 10	1/32" - 3/8"	3/8" x 24h.	37	72	78	450
CKS-10 R-3/8 BL	0,8 - 10	1/32" - 3/8"	3/8" x 24h.	37	72	78	450
CKS-10 R-1/2	0,8 - 10	1/32" - 3/8"	1/2" x 20h.	37	72	78	445
CKS-10 R-1/2 BL	0,8 - 10	1/32" - 3/8"	1/2" x 20h.	37	72	78	445
CKS-10 J-2	0,8 - 10	1/32" - 3/8"	J - 2	40	79	86	560
CKS-10 J-33	0,8 - 10	1/32" - 3/8"	J - 33	40	79	86	560
CKS-13 B-12	1 - 13	1/32" - 1/2"	B - 12	47	93	103	940
CKS-13 B-16	1 - 13	1/32" - 1/2"	B - 16	47	93	103	940
CKS-13 J-2	1 - 13	1/32" - 1/2"	J - 2	47	93	103	940
CKS-13 J-33	1 - 13	1/32" - 1/2"	J - 33	47	93	103	940
CKS-13 J-6	1 - 13	1/32" - 1/2"	J - 6	47	93	103	940
CKS-13 R-3/8	2 - 13	1/16" - 1/2"	3/8" x 24h.	40	76	83	560
CKS-13 R-3/8 BL	2 - 13	1/16" - 1/2"	3/8" x 24h.	40	76	83	585
CKS-13 R-1/2	2 - 13	1/16" - 1/2"	1/2" x 20h.	40	76	83	560
CKS-13 R-1/2 BL	2 - 13	1/16" - 1/2"	1/2" x 20h.	40	76	83	585
CKS-16 B-16	3 - 16	1/8" - 5/8"	B - 16	52	95	105	1.160
CKS-16 B-18	3 - 16	1/8" - 5/8"	B - 18	52	95	105	1.160
CKS-16 J-33	3 - 16	1/8" - 5/8"	J - 33	52	95	105	1.140
CKS-16 J-6	3 - 16	1/8" - 5/8"	J - 6	52	95	105	1.135
CKS-16 R-1/2	3 - 16	1/8" - 5/8"	1/2" x 20h.	52	95	105	1.160
CKS-16 R-5/8	3 - 16	1/8" - 5/8"	5/8" x 16h.	52	95	105	1.160
CKS-20 B-18	5 - 20	3/16" - 3/4"	B - 18	64	121	131	2.200
CKS-20 B-22	5 - 20	3/16" - 3/4"	B - 22	64	121	131	2.200
CKS-20 J-3	5 - 20	3/16" - 3/4"	J - 3	64	121	131	2.200



## CKX

### Keyless Drill Chuck with SECURITY LOCK for percussion drilling machines

- Drill chucks with self-tightening system and a safety locking device that avoids any slipping of the drill bit.
- Optimum for hammer and stationary drills with instant spindle stoppage.
- Fits tools of up to 13 mm in diameter.
- Machine fitting via DIN-238 and UNF thread fittings.

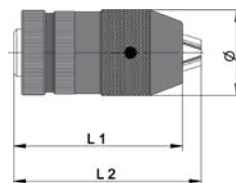

BL = blister packaging

MODEL no.	CAPACITY		MOUNT K	SIZES mm.			WEIGHT gr.
	mm.	inches		Ø	L1	L2	
CKX-10 B-12	0,8 - 10	1/32" - 3/8"	B-12	36	65	74	360
CKX-10 R-3/8	0,8 - 10	1/32" - 3/8"	3/8" x 24h.	36	65	74	350
CKX-10 R-3/8 BL	0,8 - 10	1/32" - 3/8"	3/8" x 24h.	36	65	74	350
CKX-10 R-1/2	0,8 - 10	1/32" - 3/8"	1/2" x 20h.	36	65	74	350
CKX-10 R-1/2 BL	0,8 - 10	1/32" - 3/8"	1/2" x 20h.	36	65	74	350
CKX-13 B-12	1 - 13	1/32" - 1/2"	B - 12	44	86	96	650
CKX-13 B-16	1 - 13	1/32" - 1/2"	B - 16	44	86	96	650
CKX-13 R-3/8	1 - 13	1/32" - 1/2"	3/8" x 24h.	44	86	96	670
CKX-13 R-3/8 BL	1 - 13	1/32" - 1/2"	3/8" x 24h.	44	86	96	670
CKX-13 R-1/2	1 - 13	1/32" - 1/2"	1/2" x 20h.	44	86	96	670
CKX-13 R-1/2 BL	1 - 13	1/32" - 1/2"	1/2" x 20h.	44	86	96	670

## CPL



### Keyless Drill Chuck for portable drilling machines

- Ideal for portable electric drilling machines, on mains or battery operated.
- Does not require a chuck key for tightening or loosening, enabling production increase.
- Ergonomic design, using materials which eliminate the possibility of oxidation.
- Fits any type of drill, via UNF thread, male and female.
- Wide range of ACCESSORIES (see more info in page 26).

## CPX



### Keyless Drill Chuck with PLASTIC body, LOCKING mechanism and CARBIDE JAW-inserts

- With a locking mechanism, no key is required for closing or opening, for hammer drilling and also screwdriver operations.
- Carbide jaw-inserts (for 13 mm. capacity) reduce bit slippage and enhance wear resistance.
- Ergonomic design, using materials that eliminate the possibility of rust.
- With through hole for clockwise and anticlockwise rotation.
- Supplied with screw M5 (R-3/8") or M6 (R-1/2") to fix chuck to drilling machine.
- Fits any type of drill (up to 1000 W) via UNF thread, male and female.
- Wide range of ACCESSORIES (see more info in page 26).

## CPM



### Keyless Drill Chuck with METAL BODY, LOCKING mechanism and CARBIDE JAW-inserts

- With a locking mechanism, no key is required for closing or opening, for hammer drilling and also screwdriver operations.
- Carbide jaw-inserts (for 13 mm. capacity) reduce bit slippage and enhance wear resistance.
- Ergonomic and strong design with full metal sleeves in black oxide finish that eliminates the possibility of rust.
- With through hole for clockwise and anticlockwise rotation.
- Supplied with screw M5 (R-3/8") or M6 (R1/2") to fix chuck to drilling machine.
- Fits any type of drill (up to 1000 W) via UNF thread, male and female. Wide range of ACCESSORIES (see more info in page 26).

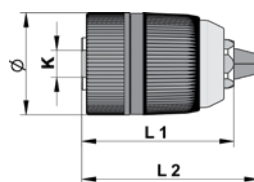

M\* = means male thread  
BL = blister packaging

MODEL no.	CAPACITY		MOUNT K	SIZES mm.			WEIGHT gr.
	mm.	inches		Ø	L1	L2	
CPL-10 R-3/8	1 - 10	1/32" - 3/8"	3/8" x 24 UNF	41	57	65	180
CPL-10 R-3/8 BL	1 - 10	1/32" - 3/8"	3/8" x 24 UNF	41	57	65	190
CPL-10 R-3/8M*	1 - 10	1/32" - 3/8"	3/8" x 24 UNF M*	41	57	65	200
CPL-10 R-3/8M* BL	1 - 10	1/32" - 3/8"	3/8" x 24 UNF M*	41	57	65	210
CPL-10 R-1/2	1 - 10	1/32" - 3/8"	1/2" x 20 UNF	41	57	65	180
CPL-10 R-1/2 BL	1 - 10	1/32" - 3/8"	1/2" x 20 UNF	41	57	65	190
CPL-13 R-3/8	2 - 13	1/16" - 1/2"	3/8" x 24 UNF	43	65	75	260
CPL-13 R-3/8 BL	2 - 13	1/16" - 1/2"	3/8" x 24 UNF	43	65	75	270
CPL-13 R-3/8M*	2 - 13	1/16" - 1/2"	3/8" x 24 UNF M*	43	65	75	280
CPL-13 R-3/8M* BL	2 - 13	1/16" - 1/2"	3/8" x 24 UNF M*	43	65	75	300
CPL-13 R-1/2	2 - 13	1/16" - 1/2"	1/2" x 20 UNF	43	65	75	260
CPL-13 R-1/2 BL	2 - 13	1/16" - 1/2"	1/2" x 20 UNF	43	65	75	270
CPL-13 SDS PLUS	2 - 13	1/16" - 1/2"	SDS PLUS	43	65	75	320

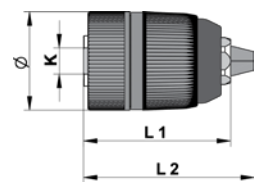

Carbide jaw-inserts

MODEL no.	CAPACITY		MOUNT K	SIZES mm.			WEIGHT gr.
	mm.	inches		Ø	L1	L2	
CPX-10 R-3/8	1 - 10	1/32" - 3/8"	3/8" x 24 UNF	41	57	66	220
CPX-10 R-3/8 BL	1 - 10	1/32" - 3/8"	3/8" x 24 UNF	41	57	66	230
CPX-10 R-3/8M*	1 - 10	1/32" - 3/8"	3/8" x 24 UNF M*	41	57	66	240
CPX-10 R-3/8M* BL	1 - 10	1/32" - 3/8"	3/8" x 24 UNF M*	41	57	66	250
CPX-10 R-1/2	1 - 10	1/32" - 3/8"	1/2" x 20 UNF	41	57	66	220
CPX-10 R-1/2 BL	1 - 10	1/32" - 3/8"	1/2" x 20 UNF	41	57	66	230
CPX-13 R-3/8	2 - 13	1/16" - 1/2"	3/8" x 24 UNF	42	65	75	280
CPX-13 R-3/8 BL	2 - 13	1/16" - 1/2"	3/8" x 24 UNF	42	65	75	290
CPX-13 R-3/8M*	2 - 13	1/16" - 1/2"	3/8" x 24 UNF M*	42	65	75	295
CPX-13 R-3/8M* BL	2 - 13	1/16" - 1/2"	3/8" x 24 UNF M*	42	65	75	300
CPX-13 R-1/2	2 - 13	1/16" - 1/2"	1/2" x 20 UNF	42	65	75	280
CPX-13 R-1/2 BL	2 - 13	1/16" - 1/2"	1/2" x 20 UNF	42	65	75	290
CPX-13 SDS PLUS	2 - 13	1/16" - 1/2"	SDS PLUS	42	65	75	340

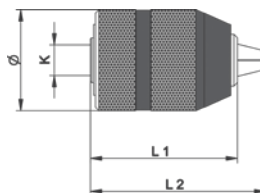

Carbide jaw-inserts

MODEL no.	CAPACITY		MOUNT K	SIZES mm.			WEIGHT gr.
	mm.	inches		Ø	L1	L2	
CPM-10 R-3/8	1 - 10	1/32" - 3/8"	3/8" x 24 UNF	41	54,5	64,5	180
CPM-10 R-3/8 BL	1 - 10	1/32" - 3/8"	3/8" x 24 UNF	41	54,5	64,5	190
CPM-10 R-3/8M*	1 - 10	1/32" - 3/8"	3/8" x 24 UNF M*	41	54,5	64,5	200
CPM-10 R-3/8M* BL	1 - 10	1/32" - 3/8"	3/8" x 24 UNF M*	41	54,5	64,5	210
CPM-10 R-1/2	1 - 10	1/32" - 3/8"	1/2" x 20 UNF	41	54,5	64,5	180
CPM-10 R-1/2 BL	1 - 10	1/32" - 3/8"	1/2" x 20 UNF	41	54,5	64,5	190
CPM-13 R-3/8	2 - 13	1/16" - 1/2"	3/8" x 24 UNF	43	62,5	74,5	260
CPM-13 R-3/8 BL	2 - 13	1/16" - 1/2"	3/8" x 24 UNF	43	62,5	74,5	270
CPM-13 R-3/8M*	2 - 13	1/16" - 1/2"	3/8" x 24 UNF M*	43	62,5	74,5	280
CPM-13 R-3/8M* BL	2 - 13	1/16" - 1/2"	3/8" x 24 UNF M*	43	62,5	74,5	300
CPM-13 R-1/2	2 - 13	1/16" - 1/2"	1/2" x 20 UNF	43	62,5	74,5	260
CPM-13 R-1/2 BL	2 - 13	1/16" - 1/2"	1/2" x 20 UNF	43	62,5	74,5	270
CPM-13 SDS PLUS	2 - 13	1/16" - 1/2"	SDS PLUS	43	62,5	74,5	320

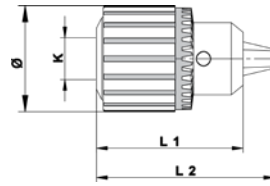

## CY

### INDUSTRIAL Drill Chuck with key for stationary machines and portable drilling machines

- Specially designed for stationary drilling, turning, milling and wood working machines.
- The one-piece gear ring and sleeve eliminate the possibility of tooth breakage.
- The jaws, gear ring and body are all totally hardened to avoid wear and lengthen the life of the drill chuck.
- Fits tools of up to 20 mm in diameter. (3/4").
- Machine fitting via DIN-238 or JACOBS tapers and UNF screw fittings.
- Wide range of ACCESSORIES (see more info in page 26).

MODEL no.	CAPACITY		MOUNT K	SIZES mm.			WEIGHT gr.
	mm.	inches		Ø	L1	L2	
CY-04 J-0	0,8 - 4	1/32" - 5/32"	J-0	22	29	36	100
CY-04 R-5/16	0,8 - 4	1/32" - 5/32"	5/16" x 24	22	28	44	130
CY-06 B-10	0,8 - 6,5	1/32" - 1/4"	B - 10	32	42	51	220
CY-06 B-12	0,8 - 6,5	1/32" - 1/4"	B - 12	32	44	54	210
CY-06 J-1	0,8 - 6,5	1/32" - 1/4"	J- 1	32	40	49	200
CY-06 R-3/8	0,8 - 6,5	1/32" - 1/4"	3/8" x 24	32	42	52	220
CY-06 R-3/8 SP*	0,8 - 6,5	1/32" - 1/4"	3/8" x 24	37	51	63	340
CY-10 B-12	1 - 10	1/32" - 3/8"	B - 12	37	51	60	300
CY-10 B-16	1 - 10	1/32" - 3/8"	B - 16	43	53	68	400
CY-10 J-1	1 - 10	1/32" - 3/8"	J- 1	37	51	60	310
CY-10 J-2	1 - 10	1/32" - 3/8"	J- 2	37	51	60	300
CY-10 J-2 SP*	1 - 10	1/32" - 3/8"	J- 2	43	55	68	420
CY-10 R-3/8	1 - 10	1/32" - 3/8"	3/8" x 24	37	51	60	300
CY-10 R-3/8 SP*	1 - 10	1/32" - 3/8"	3/8" x 24	43	53	68	420
CY-10 R-1/2	1 - 10	1/32" - 3/8"	1/2" x 20	37	51	60	300
CY-10 R-1/2 SP*	1 - 10	1/32" - 3/8"	1/2" x 20	43	53	68	420
CY-13 B-12	1,5 - 13	3/64" - 1/2"	B - 12	46	62	77	480
CY-13 B-16	1,5 - 13	3/64" - 1/2"	B - 16	46	62	77	460
CY-13 J-6	1,5 - 13	3/64" - 1/2"	J- 6	46	62	77	480
CY-13 J-33	1,5 - 13	3/64" - 1/2"	J- 33	46	62	77	480
CY-13 J-33 KD <sup>(1)</sup>	1,5 - 13	3/64" - 1/2"	33JT	46	71	86	500
CY-13 R-3/8	1,5 - 13	3/64" - 1/2"	3/8" x 24	46	62	77	500
CY-13 R-1/2	1,5 - 13	3/64" - 1/2"	1/2" x 20	46	62	77	480
CY-13 R-5/8	1,5 - 13	3/64" - 1/2"	5/8" x 16	46	62	77	490
CYX-13 J-2*	1,5 - 13	3/64" - 1/2"	J- 2	53	69	89	760
CYX-13 J-6*	1,5 - 13	3/64" - 1/2"	J- 6	53	69	89	740
CYX-13 J-33*	1,5 - 13	3/64" - 1/2"	J- 33	53	69	89	750
CYX-13 J-33C <sup>(3)</sup>	1,5 - 13	3/64" - 1/2"	33JT	53	86	106	820
CY-16 B-16	1 - 16	1/32" - 5/8"	B - 16	57	77	95	920
CY-16 B-18	1 - 16	1/32" - 5/8"	B - 18	57	77	95	920
CY-16 J-6	1 - 16	1/32" - 5/8"	J- 6	57	77	95	970
CY-16 J-33	1 - 16	1/32" - 5/8"	J- 33	57	77	95	980
CY-16 J-3	1 - 16	1/32" - 5/8"	J- 3	57	77	95	940
CY-16 J-3 KD <sup>(1)</sup>	1 - 16	1/32" - 5/8"	3JT	57	85	102	980
CY-16 J-3 PD <sup>(2)</sup>	1 - 16	1/32" - 5/8"	3JT	57	85	102	980
CY-16 R-1/2	1 - 16	1/32" - 5/8"	1/2" x 20	57	77	95	990
CY-16 R-5/8	1 - 16	1/32" - 5/8"	5/8" x 16	57	77	95	1.000
CY-19 B-22	3 - 20	13/64" - 3/4"	B - 22	65	85	110	1.440
CY-19 J-3	3 - 20	13/64" - 3/4"	J- 3	65	85	110	1.440
CY-19 J-3 KD <sup>(1)</sup>	3 - 20	13/64" - 3/4"	3JT	65	89	116	1.440
CY-19 J-3 PD <sup>(2)</sup>	3 - 20	13/64" - 3/4"	3JT	65	89	116	1.360
CY-19 J-4	3 - 20	13/64" - 3/4"	J- 4	68	97	120	1.500
CY-19 R-3/4	3 - 20	13/64" - 3/4"	3/4" x 16	65	85	110	1.500
CY-19 R-5/8	3 - 20	13/64" - 3/4"	5/8" x 16	65	85	110	1.540

\* Extra heavy duty model

<sup>(1)</sup> Equipped with positive drive slot

<sup>(2)</sup> Equipped with pin type positive drive

<sup>(3)</sup> Equipped with locking collar

# CBB

## BALL-BEARING Drill Chuck with key for production drilling equipment



- Drill chuck with key for industrial applications that require the toughest machining conditions.
- Equipped with ball bearings to reduce friction in the tightening mechanism and provide a better grip on the drill shaft.
- All the pieces are hardened and ground.
- The one-piece gear ring and sleeve eliminate the possibility of tooth breakage.
- Fits tools of up to 25 mm. (1"), machine fitting via Jacobs tapers.

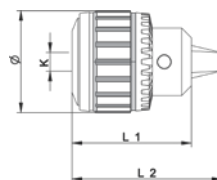

MODEL no.	CAPACITY		MOUNT K	SIZES mm.			WEIGHT gr.
	mm.	inches		Ø	L1	L2	
CBB-08 J2	1 - 8	1/32" - 5/16"	J - 25	47	55	70	500
CBB-10 J2	1 - 10	1/32" - 3/8"	J - 25	47	55	70	500
CBB-13 J3	1 - 13	1/32" - 1/2"	J - 3	62	75	94	1.115
CBB-13 J6	1 - 13	1/32" - 1/2"	J - 6	62	75	94	1.120
CBB-16 J3	1 - 16	1/32" - 5/8"	J - 3	67	81	102	1.470
CBB-19 J4	1 - 20	1/32" - 3/4"	J - 4	75	99	125	2.145
CBB-25 J5	5 - 25	13/64" - 1"	J - 5	93	112	147	3.645

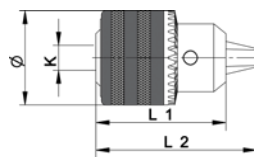

# CL

## LIGHT-DUTY Drill Chuck with key for portable drilling machines



- Ideal for electric portable drilling machines, with or without batteries, cutting direction reversible or non reversible.
- Fits tools of up to 16 mm.
- Fits to machine via UNF screw fittings, male and female, DIN-238 and E-6.3.
- Wide range of ACCESSORIES (see more info in page 26).

MODEL no.	CAPACITY		MOUNT K	SIZES mm.			WEIGHT gr.
	mm.	inches		Ø	L1	L2	
CL-06 B-10	0,8 - 6,5	1/32" - 1/4"	B-10	30	44	55	180
CL-06 R-3/8	0,8 - 6,5	1/32" - 1/4"	3/8"x24h	30	44	55	190
CL-06 R-3/8 BL	0,8 - 6,5	1/32" - 1/4"	3/8"x24h	30	44	55	200
CL-06 ATOR	0,8 - 6,5	1/32" - 1/4"	E-6,3	30	44	55	205
CL-10 B-12	1 - 10	1/32" - 3/8"	B-12	33	50	60	240
CL-10 R-3/8	1 - 10	1/32" - 3/8"	3/8"x24h	33	50	60	240
CL-10 R-3/8 BL	1 - 10	1/32" - 3/8"	3/8"x24h	33	50	60	255
CL-10 R-3/8M*	1 - 10	1/32" - 3/8"	3/8"x24h M*	33	50	60	255
CL-10 R-3/8M* BL	1 - 10	1/32" - 3/8"	3/8"x24h M*	33	50	60	270
CL-10 R-1/2	1 - 10	1/32" - 3/8"	1/2"x20h.	33	50	60	235
CL-10 R-1/2 BL	1 - 10	1/32" - 3/8"	1/2"x20h.	33	50	60	245
CL-10 ATOR	1 - 10	1/32" - 3/8"	E-6,3	33	50	60	255
CL-13 B-12	1,5 - 13	3/64" - 1/2"	B-12	43	59	73	360
CL-13 B-16	1,5 - 13	3/64" - 1/2"	B-16	43	59	73	355
CL-13 R-3/8	1,5 - 13	3/64" - 1/2"	3/8"x24h	43	59	73	380
CL-13 R-3/8 BL	1,5 - 13	3/64" - 1/2"	3/8"x24h	43	59	73	390
CL-13 R-3/8M*	1,5 - 13	3/64" - 1/2"	3/8"x24h M*	43	59	73	395
CL-13 R-3/8M* BL	1,5 - 13	3/64" - 1/2"	3/8"x24h M*	43	59	73	410
CL-13 R-1/2	1,5 - 13	3/64" - 1/2"	1/2"x20h.	43	59	73	375
CL-13 R-1/2 BL	1,5 - 13	3/64" - 1/2"	1/2"x20h.	43	59	73	385
CL-13 R-5/8	1,5 - 13	3/64" - 1/2"	5/8"x16h.	43	59	73	390
CL-13 R-5/8 BL	1,5 - 13	3/64" - 1/2"	5/8"x16h.	43	59	73	395
CL-13 SDS PLUS	1,5 - 13	3/64" - 1/2"	SDS PLUS	43	59	73	420
CL-16 B-16	3 - 16	1/8" x 5/8"	B-16	54	66	85	685
CL-16 B-18	3 - 16	1/8" x 5/8"	B-18	54	66	85	685
CL-16 R-1/2	3 - 16	1/8" x 5/8"	1/2"x20h.	54	66	85	685
CL-16 R-5/8	3 - 16	1/8" x 5/8"	5/8"x16h.	54	66	85	695
CL-16 SDS PLUS	3 - 16	1/8" x 5/8"	SDS PLUS	54	66	85	730

# SDS

## Quick Change drill chuck for SDS drills



- Most suitable to fix SDS drills in percussion drilling machines.
- Quick Change system enabling production increase.

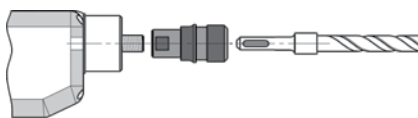

MODEL no.	MOUNT K	WEIGHT gr.
SDS-CONVERT	12" x 20 UNF	180

# ARBORS for Drill Chucks

**Taper Arbors: DIN-238 and JACOBS**  
**Threaded arbors: UNF**

- The arbor is an intermediary gripping element between the drill chuck (type CKS, SP and SPX) and the spindle of the machine.
- Lambrich arbors are totally hardened and precision ground, ensuring a close fit.
- Available in a wide range of DIN-238, JACOBS Morse tapers and UNF thread.
- Maximum concentricity.



MODEL	TAPER		SIZES mm.						WEIGHT
no.	Morse	DIN-238	Ø1	Ø2	Ø3	L1	L2	L3	gr.
E-10/1	1	10	12,065	10,095	9,4	62	14,5	85	60
E-12/1	1	12	12,065	12,065	11,1	62	18,5	89	66
E-12/2	2	12	17,78	12,065	11,1	75	18,5	106	145
E-12/3	3	12	23,825	12,065	11,1	94	18,5	126	305
E-16/1	1	16	12,065	15,733	14,5	62	24	99	90
E-16/2	2	16	17,78	15,733	14,5	75	24	111	170
E-16/3	3	16	23,825	15,733	14,5	94	24	134	335
E-16/4	4	16	31,267	15,733	14,5	117,5	24	158	650
E-16/5	5	16	44,399	15,733	14,5	149,5	24	194	1.585
E-18/1	1	18	12,065	17,78	16,2	62	32	96	105
E-18/2	2	18	17,78	17,78	16,2	75	32	118	200
E-18/3	3	18	23,825	17,78	16,2	94	32	140	355
E-18/4	4	18	31,267	17,78	16,2	117,5	32	166,5	675
E-18/5	5	18	44,399	17,78	16,2	149,5	32	202	1.605
E-18c*/1	1	18c*	12,065	17,42	16,2	62	23	86	90
E-18c*/2	2	18c*	17,78	17,42	16,2	75	23	108	185
E-18c*/3	3	18c*	23,825	17,42	16,2	94	23	131	325
E-18c*/4	4	18c*	31,267	17,42	16,2	117,5	23	158	650
E-18c*/5	5	18c*	44,399	17,42	16,2	149,5	23	189	1.570
E-22/2	2	22	17,78	21,793	19,8	75	40,5	130	265
E-22/3	3	22	23,825	21,793	19,8	94	40,5	147	410
E-22/4	4	22	31,267	21,793	19,8	117,5	40,5	176	740
E-22/5	5	22	44,399	21,793	19,8	149,5	40,5	213	1.665

MODEL	TAPER		SIZES mm.						WEIGHT
no.	Morse	JACOBS	Ø1	Ø2	Ø3	L1	L2	L3	gr.
E-J0/1	1	0	12,065	6,35	5,8	62	11,1	80	50
E-J1/1	1	1	12,065	9,754	8,5	62	16,7	84	56
E-J2/1	1	2	12,065	14,199	12,4	62	22,2	91	80
E-J3/1	1	3	12,065	20,599	19	62	31	101	135
E-J6/1	1	6	12,065	17,17	15,9	62	25,4	95	100
E-J33/1	1	33	12,065	15,85	14,2	62	25,4	95	95
E-J1/2	2	1	17,78	9,754	8,5	75	16,7	101	136
E-J2/2	2	2	17,78	14,199	12,4	75	22,2	106	155
E-J3/2	2	3	17,78	20,599	19	75	31	113	206
E-J6/2	2	6	17,78	17,17	15,9	75	25,4	107	170
E-J33/2	2	33	17,78	15,85	14,2	75	25,4	107	165
E-J1/3	3	1	23,825	9,754	8,5	94	16,7	120	290
E-J2/3	3	2	23,825	14,199	12,4	94	22,2	126	310
E-J3/3	3	3	23,825	20,599	19	94	31	132	360
E-J6/3	3	6	23,825	17,17	15,9	94	25,4	129	330
E-J33/3	3	33	23,825	15,85	14,2	94	25,4	127	310
E-J4/3	3	4	23,825	28,55	26,3	94	42,1	142	495
E-J5/3	3	5	23,825	35,89	33,4	94	47,6	150	640
E-J2/4	4	2	31,267	14,199	12,4	117,5	22,2	151	630
E-J3/4	4	3	31,267	20,599	19	117,5	31	161	690
E-J6/4	4	6	31,267	17,17	15,9	117,5	25,4	155	650
E-J33/4	4	33	31,267	15,85	14,2	117,5	25,4	155	640
E-J4/4	4	4	31,267	28,55	26,3	117,5	42,1	170	810
E-J5/4	4	5	31,267	35,89	33,4	117,5	47,6	175	1.000
E-J3/5	5	3	44,399	20,599	19	149,5	31	192	1.580
E-J4/5	5	4	44,399	28,55	26,3	149,5	42,1	200	1.700
E-J5/5	5	5	44,399	35,89	33,4	149,5	47,6	210	1.920
E-J6/5	5	6	44,399	17,17	15,9	149,5	25,4	185	1.540

MODEL	MORSE	THREAD	SIZES mm.						WEIGHT
no.	taper	UNF	Ø1	Ø2	Ø3	L1	L2	L3	gr.
E-MT2-3/8	2	3/8" x 24	17,78	9,28	-	75	13,02	97	140
E-MT2-1/2	2	1/2" x 20	17,78	12,52	-	75	15,85	100	160
E-MT2-5/8	2	5/8" x 16	17,78	15,86	-	75	17,75	103	180

Arbors DIN-238 taper

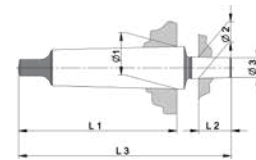

\* For SP, SPX and CKS,  
with shortered B18 taper

Arbors Jacobs taper

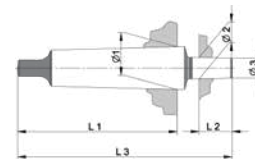

Threaded arbors UNF

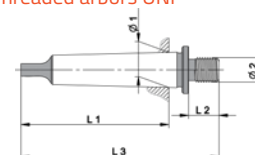

## Drill SLEEVES

DIN-2185

- Completely hardened and ground, both internally and externally.
- Wide range.



MODEL no.	MORSE TAPER		SIZES mm.		WEIGHT gr.
	outside	inside	Ø1	L1	
CR-2 x 1	2	1	12,065	92	100
CR-3 x 1	3	1	12,065	99	220
CR-3 x 2	3	2	17,78	112	190
CR-4 x 1	4	1	12,065	124	535
CR-4 x 2	4	2	17,78	124	460
CR-4 x 3	4	3	23,825	140	405
CR-5 x 1	5	1	12,065	156	1.700
CR-5 x 2	5	2	17,78	156	1.520
CR-5 x 3	5	3	23,825	156	1.360
CR-5 x 4	5	4	31,267	171	950
CR-6 x 2	6	2	17,78	219	4.300
CR-6 x 3	6	3	23,825	219	4.100
CR-6 x 4	6	4	31,267	219	3.600
CR-6 x 5	6	5	44,39	219	2.550

## Extension SLEEVES

DIN-2187

- Completely hardened and ground, both internally and externally.
- Wide range.

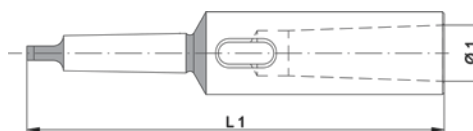

MODEL no.	MORSE TAPER		SIZES mm.		WEIGHT gr.
	outside	inside	Ø1	L1	
CP 1x1	1	1	12,065	145	190
CP 1x2	1	2	17,78	160	400
CP 2x1	2	1	12,065	160	290
CP 2x2	2	2	17,78	175	500
CP 2x3	2	3	23,825	196	600
CP 3x1	3	1	12,065	175	410
CP 3x2	3	2	17,78	194	620
CP 3x3	3	3	23,825	215	890
CP 3x4	3	4	31,267	240	1.550
CP 4x1	4	1	12,065	200	810
CP 4x2	4	2	17,78	215	1.000
CP 4x3	4	3	23,825	240	1.270
CP 4x4	4	4	31,267	265	1.930
CP 4x5	4	5	44,39	300	3.180
CP 5x1	5	1	12,065	232	1.790
CP 5x2	5	2	17,78	247	2.000
CP 5x3	5	3	23,825	268	2.270
CP 5x4	5	4	31,267	300	2.930
CP 5x5	5	5	44,39	335	4.180
CP 6x4	6	4	31,267	355	5.180
CP 6x5	6	5	44,39	390	6.430

## EJECTORS

DIN-317

- Tempered steel.
- To eject Morse tapers arbors from sleeves or machine spindle.



MODEL no.	FOR MORSE TAPER K	WEIGHT gr.
CE 1 - 2	1, 2	40
CE 2 - 3	2, 3	80
CE 3 - 4	3, 4	160
CE 4 - 5	4, 5	340
CE 5 - 6	5, 6	620

# Revolving Lathe Centres

For accurate work holding in conventional or CNC lathes

- Lambrich revolving lathe centres are of high precision, with a maximum run-out of 0.003 mm for Morse tapers no. 2, 3, 4 and 0.004 mm for Morse taper no. 5.
- Capable of bearing up to 1,000 kg workload and speeds of up to 5,000 rpm, according to the model.
- Fully hardened and precision ground.
- Standard or extended spindle configurations.
- Maintenance free.

### Model N

For a wide range of general turning work.

### Model C

Increases tool clearance and operator visibility for work on small parts or machining close to workpiece end.

### Model H

With centre bore 60° and metric taper point (1:20) that permits attachment of special purpose accessories.

### Note 1

The special purpose accessories are not supplied by Lambrich.

### Note 2

Lambrich revolving lathe centres may reach temperatures of up to 80° C due to the fine adjustment of the bearings with the spindle.



The use of needle bearings in the head and end of the turning axle, as well as the assembly of precision axial bearings, means that heavy duty work can be carried out with reduced body sizes.

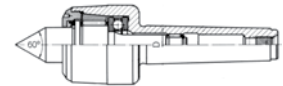

MODEL	MAXIMUM RUN-OUT
R-200	0,003 mm.
R-300	0,003 mm.
R-400	0,003 mm.
R-500	0,004 mm.

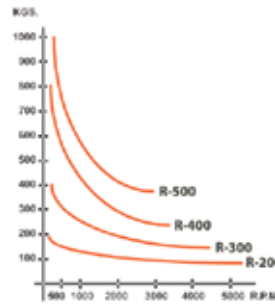

RADIAL LOAD  
2.000 hours tool life

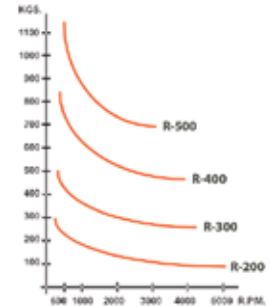

AXIAL LOAD  
2.000 hours tool life

MODEL	MORSE	LOAD FACTOR	SIZES mm.						WEIGHT
no.	taper	kg.	Ø1	Ø2	Ø3	L1	L2	L3	gr.
R-200-N	2	180	18	42	-	24	35	128	430
R-300-N	3	400	22	49	-	29	47	163	875
R-400-N	4	800	30	63	-	35	52	196	1.505
R-500-N	5	1.750	33	85	-	48	64	250	3.955
R-300-C	3	400	22	49	10	38	47	174	875
R-400-C	4	800	30	63	11	46	52	207	1.505
R-500-C	5	1.750	33	85	18	64	64	266	3.955
R-300-H	3	550	22	49	-	47	47	163	905
R-400-H	4	900	24	63	-	52	52	196	1.540
R-500-H	5	2.100	35	85	-	64	64	250	4.035

### Model N

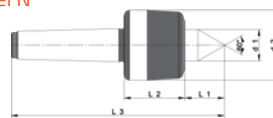

### Model C

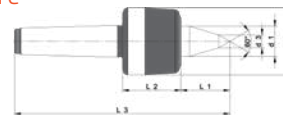

### Model H

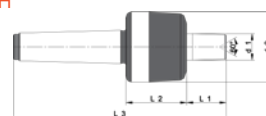



# Revolving Lathe Centres

## With small casing diameter

- With small diameter for optimum accessibility.
- Additional bearings to compensate the axial load.
- Morse tapers hardened and ground.
- High concentricity.
- Lubricated for life, maintenance free.



### Model RN

For a wide range of general turning work.

### Models RC & RE

Increases tool clearance and operator visibility for work on small parts or machining close to workpiece end.

MODEL	MAXIMUM RUN-OUT
R-200	0,005 mm.
R-300	0,005 mm.
R-400	0,005 mm.
R-500	0,008 mm.

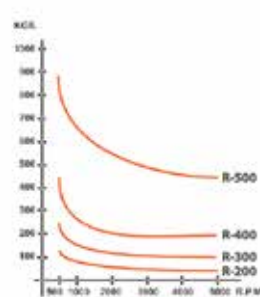

**RADIAL LOAD**  
2.000 hours tool life

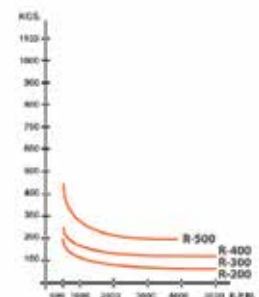

**AXIAL LOAD**  
2.000 hours tool life

MODEL	MORSE	LOAD FACTOR	SIZES mm.						WEIGHT
no.	taper	kg.	Ø1	Ø2	Ø3	L1	L2	L3	gr.
R-200-RN	2	200	15	32	-	20	39	127	300
R-300-RN	3	400	15	34	-	20	40	145	500
R-400-RN	4	800	20	43	-	26	42	180	1.000
R-500-RN	5	1.200	30	58	-	37	60	235	2.500
R-200-RC	2	150	15	32	8	30	39	137	300
R-300-RC	3	300	15	34	8	30	40	155	500
R-400-RC	4	700	20	43	10	36	42	190	1.000
R-500-RC	5	1.000	30	58	12	51	60	245	2.500
R-200-RE	2	130	15	32	6	30	39	137	300
R-300-RE	3	280	15	34	8	31	40	155	500
R-400-RE	4	650	20	43	10	38	42	190	1.000
R-500-RE	5	930	30	58	12	49	60	245	2.500

### Model RN

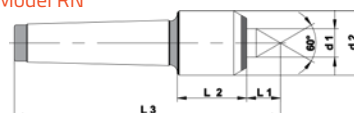

### Model RC

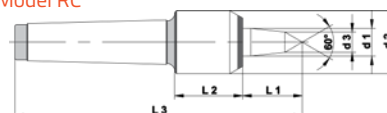

### Model RE

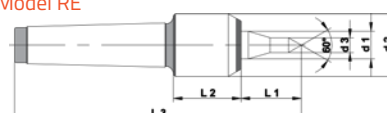

## Spare Parts for SP, SPX, SPS, NPU and HEXA Drill Chucks

REFERENCE	FOR DRILL CHUCKS	SIZES
no.	capacity (mm.)	AxB mm.
SP-01061	0 - 1,5	2 x 1,3
SP-03061	0 - 3	2,5 x 1,5
SP-06061	0 - 6,5	3,75 x 1,5
SP-08062	0 - 8	4,4 x 2,5
SP-10061	0 - 10	4,4 x 2,5
SP-13062	1- 13	5 x 2,5
SP-16062	3 - 16	5 x 2,5

REFERENCE	FOR DRILL CHUCKS
no.	model
SP-0105	SP-1,5
SP-0305	SP / NPU-03
SP-0605	SP / NPU-06
SP-0805	SP / SPX-08
SP-1005	SP / SPX-10
SP-1305	SP / SPX-13
SP-1605	SP / SPX-16
NPU-0805	NPU / SPS-08
NPU-1005	NPU / SPS-10
NPU-1305*	NPU* / SPS-13
NPU-13051**	NPU-13**
NPU-1605	NPU / SPS-16
SP-0104	SP-1,5
SP-0304	SP / NPU-03
SP-0604	SP / NPU-06
SP-0804	SP / SPX / SPS / NPU-08
SP-1004	SP / SPX / SPS / NPU-10
SP-1304	SP / SPX / SPS / NPU-13
SP-1604	SP / SPX / SPS / NPU-16
PS-1304	HX-13
PS-1604	HX-16
SPX-0612	SPX-06
SPX-0812	SPX / SPS / NPU-08
SPX-1012	SPX / SPS / NPU-10
SPX-1312	SPX / SPS*** / NPU-13
SPX-1612	SPX / SPS / NPU-16
HX-1012	HX-10
HX-1312	HX-13 / HX-16

\* P=3 mm.

\*\* P=2,25mm. (for models NPU-13 from May 2000)

\*\*\*Ref. nos. SPS-13 MT-4, CIL-32 and R-8, require SPX-1612 wrench

## Accessories for CHUCK® Class Drill Chucks

REFERENCE	THREAD	FITTING
no.		
C - 51	3/8" x 24	3/8" x 24
C - 52	3/8" x 24	1/2" x 20
C - 53	1/2" x 20	SDS - PLUS*
C - 54	3/8" x 24	Hex. 1/4" DIN-3126
C - 56	M6	1/2" x 20
C - 57	M5	3/8" x 24

\* C - 53 includes screw M6 left.

## Accessories for CHUCK® Class Drill Chucks

Keys for CL, CY, CBB, CSS and Hybrid drill chucks

REFERENCE	D	TEETH	FOR DRILL CHUCKS
no.	mm.	no.	model
S2/K34	6	12	CL-13, CY-10
S8/K30	6	10	CBB-08
S9/K32	6,3	10	CBB-10
S10/K3	8	11	CL-16, CY-16, CBB13, CYX13, SPH-13, SPH-16 (Hybrid)
S13/K4	9,5	12	CY-19, CBB-16, CBB-19, SPH-20
S14/KG	6	11	CL-06, CL-10
S17/K2	6,3	11	CY-13, SPH-06, SPH-10
CK4	5,5	12	CY-06
K0	3,2	11	CY-04
K5	11	12	CBB-25
K0M	3,2	11	CSS-04 GE
K1M	4	11	CSS-06 GE-DS
K0T	3,2	11	SPH-03
K1T	4	11	SPH-07
K10M	5,5	12	CSS-10

Key

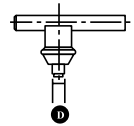

STAINLESS STEEL

## Spare Parts for CKS Drill CHUCK® Chucks

REFERENCE	FOR DRILL CHUCKS
no.	model
CKS-0406	CKS-04
CKS-0686	CKS-06
SP-08062	CKS-08, CKS-10, CKS-13 <sup>(1)</sup>
SP-13062	CKS-13 <sup>(2)</sup> , CKS-16
SP-16062	CKS-20
CKS-0405	CKS-04
CKS-0605	CKS-06
SP-1005	CKS-08, CKS-10
CKS-13051	CKS-13 <sup>(1)</sup>
SP-1305	CKS-13 <sup>(2)</sup>
CKS-16051	CKS-16
CKS-20051	CKS-20
CKS-0404	CKS-04
CKS-0684	CKS-06
CKS-08041	CKS-08, CKS-10 <sup>(1)</sup>
CKS10041	CKS-10 <sup>(2)</sup>
CKS-13041	CKS-13 <sup>(2)</sup>
CKS-13042	CKS-13 <sup>(1)</sup>
CKS-16041	CKS-16
CKS-20041	CKS-20

Jaws (set of 3)



Screw

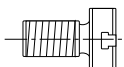

Hood

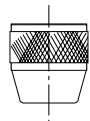
<sup>(1)</sup> Drill chuck with thread mount UNF.<sup>(2)</sup> Drill chucks with taper DIN or JACOBS.

Jaws (set of 3)

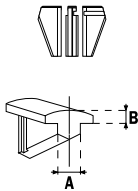

Screw

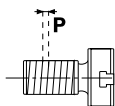

Hood

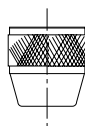

Wrenches

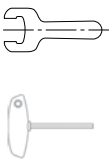

Adapters

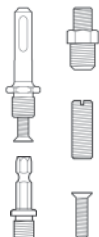

# LLAMBRICH

*The world's most complete drill chuck program*



[www.llambrich.com](http://www.llambrich.com)

# LLAMBRICH

Since 1957

● **LLAMBRICH Precisión, S.L.**

Av. Mare de Déu de Bellvitge, 271-273  
E-08907 L'Hospitalet de Llobregat  
Barcelona - Spain

Tel. +34 93 264 96 23

Fax +34 93 263 40 10

[www.llambrich.com](http://www.llambrich.com)

[info@llambrich.com](mailto:info@llambrich.com)